

Alle Rechte vorbehalten/ All rights reserved

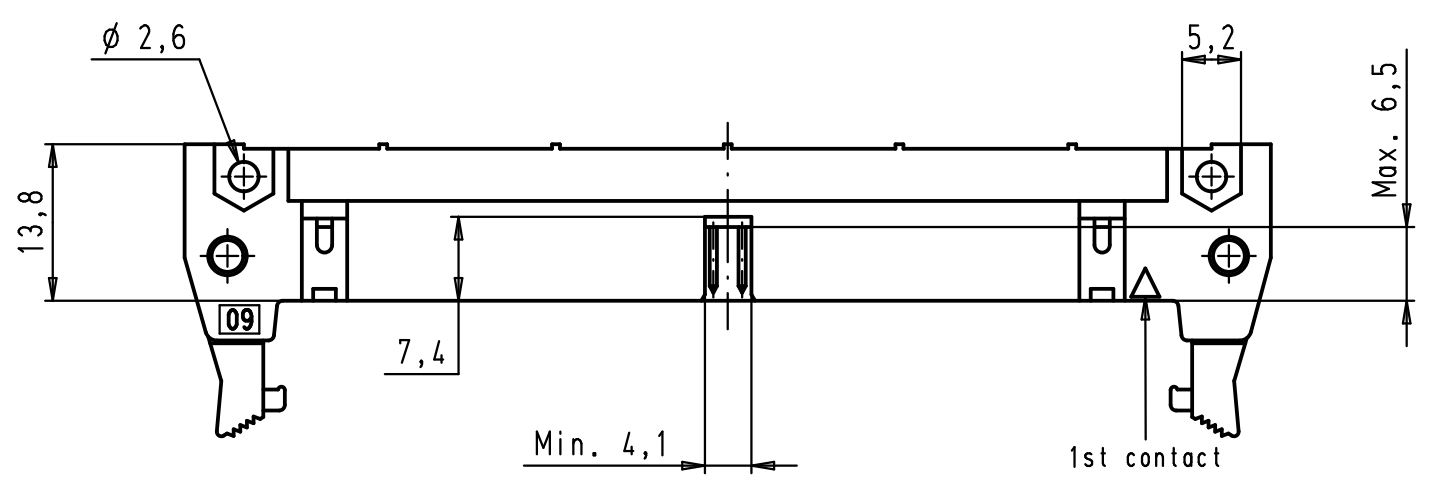

PCB layout, component side

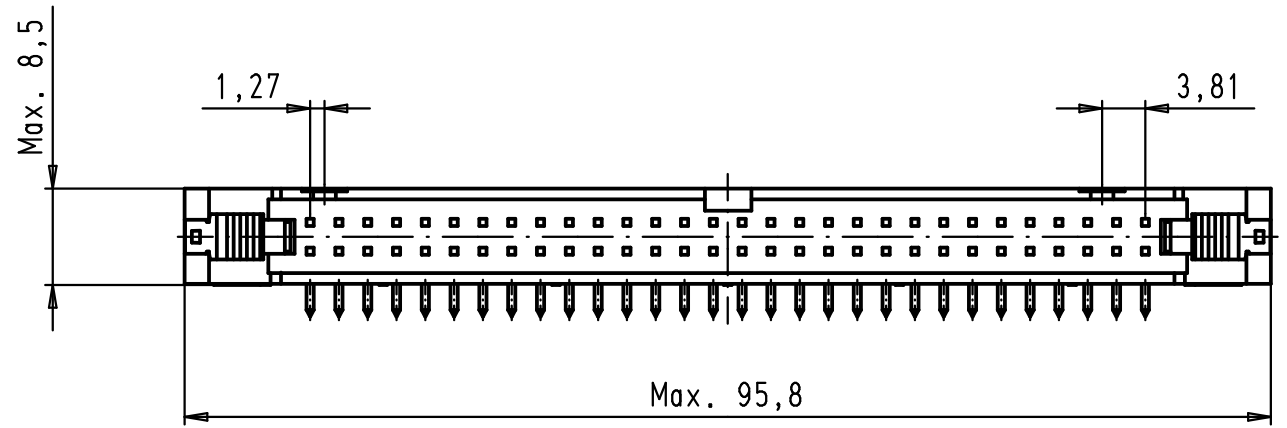
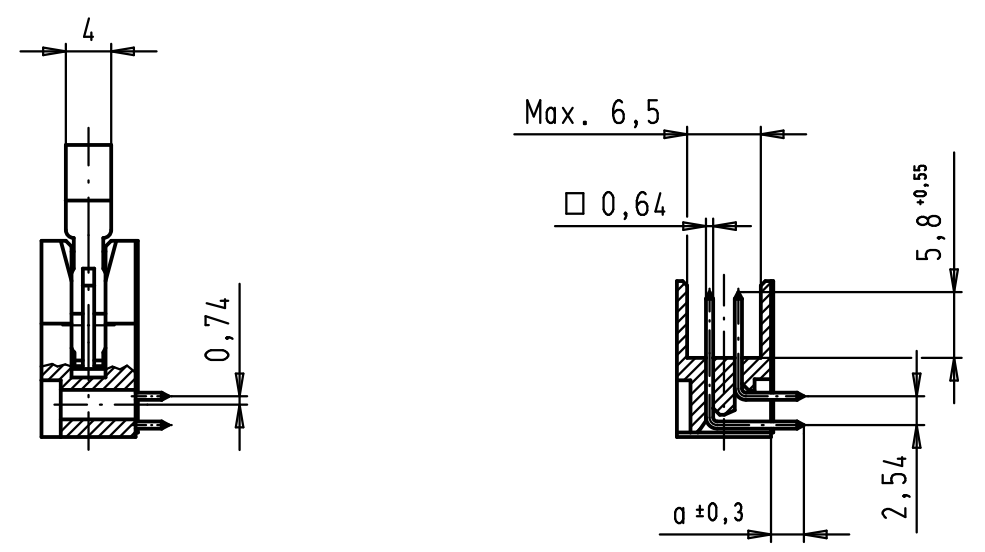
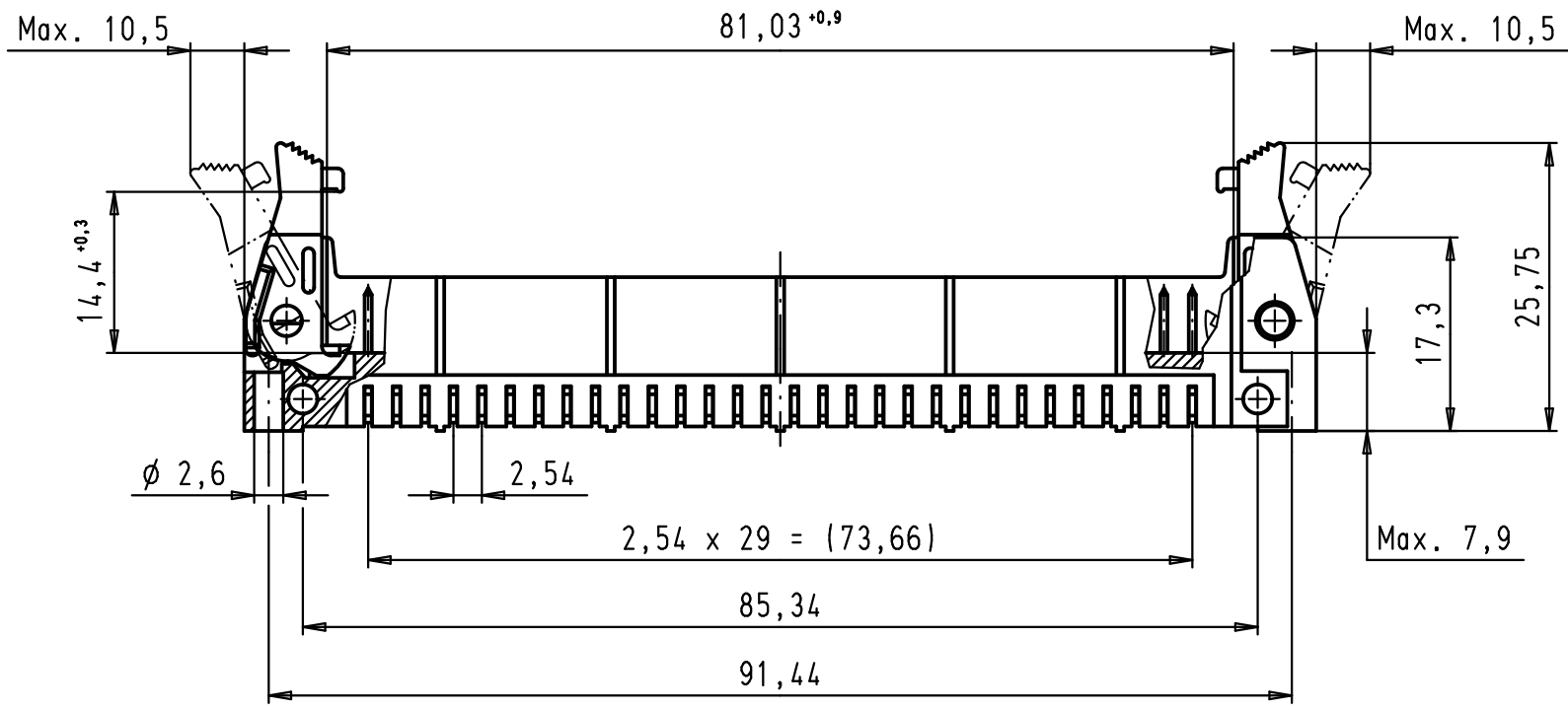
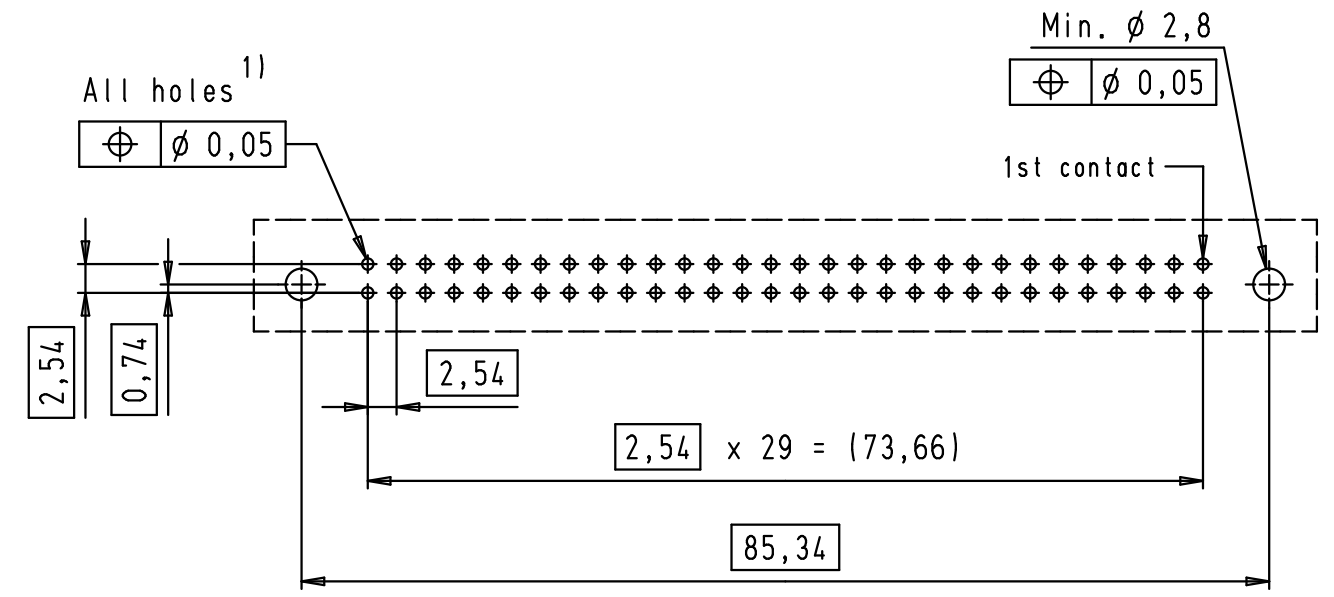

1) Solder pins for PCB connections
 $\phi 1 \pm 0,1$ according to IEC 60 326-3

09 18 560 7901	3	4,5
09 18 560 6901	2	4,5
09 18 560 5901	0,76 $\mu\text{m Au}$	4,5
09 18 560 7903	3	2,9
09 18 560 6903	2	2,9
09 18 560 5903	0,76 $\mu\text{m Au}$	2,9
Part number	Performance level	a

				Det.	Name	 All Dim. in mm Orig. Size DIN A 3	SEK 18 Male Connector Standard 60 poles Angled pins Long locking levers	Maßstab/ Scale 1,5:1
34890	31/01/08	PK	Detail.	01/12/99	JB			
29753	11/03/02	JB	Insp.					
29739	03/12/01	JB	Stand.					
27931	15/06/00	JB						
26554	01/12/99	JB						
Mod.	Det.	Name	HARTING EURL F-95972 Paris				TB 09 18 560 X90X	Blatt/ Page 2 / 2