



Pushing Performance

HARTING Han-Yellock®



Transforming customer wishes into concrete solutions



The HARTING Technology Group is skilled in the fields of electrical, electronic and optical connection, transmission and networking, as well as in manufacturing, mechatronics and software creation.

The Group uses these skills to develop customized solutions and products such as connectors for energy and data transmission applications including, for example, mechanical engineering, rail technology, wind energy plants, factory automation and the telecommunications sector. In addition, HARTING also produces electromagnetic components for the automobile industry and offers solutions in the field of Enclosures and Shop Systems.

The HARTING Group currently comprises 32 subsidiary companies and worldwide distributors employing a total of approximately 3,000 staff.



HARTING Subsidiary company



HARTING Representatives



WE ASPIRE TO TOP PERFORMANCE.

Connectors ensure functionality. As core elements of electrical and optical wiring, connection and infrastructure technologies, they are essential in enabling the modular construction of devices, machines and systems across a very wide range of industrial applications. Their reliability is a crucial factor guaranteeing smooth functioning in the manufacturing area, in telecommunications, applications in medical technology – in fact, connectors are at work in virtually every conceivable application area. Thanks to the consistent further development of our technologies, customers enjoy investment security and benefit from durable, long term functionality.

ALWAYS AT HAND, WHEREVER OUR CUSTOMERS MAY BE.

Increasing industrialization is creating growing markets characterized by widely diverging demands and requirements. The search for perfection, increasingly efficient processes and reliable technologies is a common factor in all sectors across the globe. HARTING is providing these technologies – in Europe, America and Asia. The HARTING professionals at our international subsidiaries engage in close, partnership based interaction with our customers, right from the very early product development phases, in order to realize customer demands and requirements in the best possible manner.

Our people on location form the interface to the centrally coordinated development and production departments. In this way, our customers can rely on consistently high, superior product quality – worldwide.

OUR CLAIM: PUSHING PERFORMANCE.

HARTING provides more than optimally attuned components. In order to serve our customers with the best possible solutions, HARTING is able to contribute a great deal more and play a closely integrative role in the value creation process.

From ready assembled cables through to control racks or ready-to-go control desks: Our aim is to generate the maximum benefits for our customers – without compromise!

QUALITY CREATES RELIABILITY – AND WARRANTS TRUST.

The HARTING brand stands for superior quality and reliability – worldwide. The standards we set are the result of consistent, stringent quality management that is subject to regular certifications and audits.

EN ISO 9001, the EU Eco-Audit and ISO 14001:2004 are key elements here. We take a proactive stance to new requirements, which is why HARTING ranks among the first companies worldwide to have obtained the new IRIS quality certificate for rail vehicles.

HARTING TECHNOLOGY CREATES ADDED VALUE FOR CUSTOMERS.

Technologies by HARTING are at work worldwide. HARTING's presence stands for smoothly functioning systems, powered by intelligent connectors, smart infrastructure solutions and mature network systems. In the course of many years of close, trust-based cooperation with its customers, the HARTING Technology Group has advanced to one of the worldwide leading specialists for connector technology. Extending beyond the basic functionalities demanded, we offer individual customers specific and innovative solutions. These tailored solutions deliver sustained effects, provide investment security and enable customers to achieve strong added value.

OPTING FOR HARTING OPENS UP AN INNOVATIVE, COMPLEX WORLD OF CONCEPTS AND IDEAS.

In order to develop connectivity and network solutions serving an exceptionally wide range of connector applications and task scopes in a professional and cost optimized manner, HARTING not only

commands the full array of conventional tools and basic technologies. Over and beyond these capabilities, HARTING is constantly harnessing and refining its broad base of knowledge and experience to create new solutions that ensure continuity at the same time. In securing this know-how lead, HARTING draws on a wealth of sources from both in-house research and the world of applications alike.

Salient examples of these sources of innovative knowledge include microstructure technologies, 3D design and construction technology, as well as high temperature or ultrahigh frequency applications that are finding use in telecommunications or automation networks, in the automotive industry, or in industrial sensor and actuator applications, RFID and wireless technologies, in addition to packaging and housing made of plastics, aluminum or stainless steel.

HARTING SOLUTIONS EXTEND ACROSS TECHNOLOGY BOUNDARIES.

Drawing on the comprehensive resources of the group's technology pool, HARTING devises

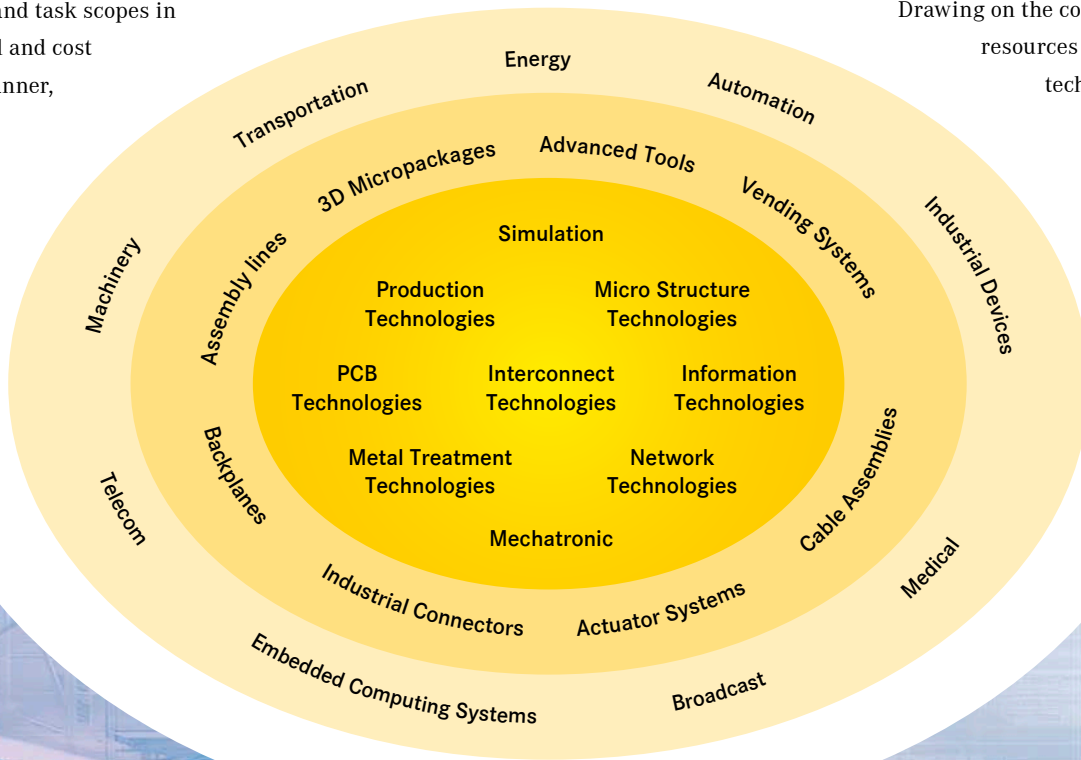

practical solutions for its customers. Whether this involves industrial networks for manufacturing automation, or hybrid interface solutions for wireless telecommunication infrastructures, 3D circuit carriers with microstructures, or cable assemblies for high-temperature applications in the automotive industry - HARTING technologies offer far more than components, and represent mature, comprehensive solutions attuned to individual customer requirements and wishes. The range covers ready-to-use cable configurations, completely assembled backplanes and board system carriers, as well as fully wired and tested control panels.

In order to ensure the future proof design of RF- and EMC-compatible interface solutions, the central HARTING laboratory (certified to EN 45001) provides simulation tools, as well as experimental, testing and diagnostics facilities all the way through to scanning electron microscopes. In the selection of materials and processes, lifecycle and environmental aspects play a key role, in addition to product and process capability considerations.

HARTING KNOWLEDGE IS PRACTICAL KNOW-HOW GENERATING SYNERGY EFFECTS.

HARTING commands decades of experience with regard to the applications conditions of connectors in telecommunications, computer and network technologies and medical technologies, as well as industrial automation technologies, such as the mechanical engineering and plant engineering areas, in addition to the power generation industry or the transportation sector. HARTING is highly conversant with the specific application areas in all of these technology fields.

The key focus is on applications in every solution approach. In this context, uncompromising, superior quality is our hallmark. Every new solution found will invariably flow back into the HARTING technology pool, thereby enriching our resources. And every new solution we go on to create will draw on this wealth of resources in order to optimize each and every individual solution. In this way, HARTING is synergy in action.



Field of application

HARTING Industrial Connectors are applicable in a wide variety of electronic and electrical applications. The degree of protection of all hoods and housings is in accordance with International Standard IEC 60 529, EN 60 529.

- Power Utilities
- Robotics
- Chemical Plants
- Machine Tool Controls
- Injection Moulding
- Industrial Instrumentation
- Conveyor Equipment
- Cabinet builders
- and many more.



Certified according to EN ISO 9001 in design/development, production, installation and servicing

Specifications:

DIN EN 60 664-1
Table concerning clearance and creepage distances

DIN EN 61 984
Connectors and plug devices

Note:

Connectors should not be coupled and decoupled under electrical load. Connectors of the same or different series being mounted side by side may be protected against incorrect mating by the use of coding options.

General information:

It is the user's responsibility to check whether the components illustrated in this catalogue comply with different regulations from those stated in special fields of application which we are unable to foresee.

We reserve the right to modify designs in order to improve quality, keep pace with technological advancement or meet particular requirements in production.

No part of this catalogue may be reproduced in any form (print, photocopy, microfilm or any other process) or processed, duplicated or distributed by means of electronic systems without the prior written consent of HARTING Electric GmbH & Co. KG, Espelkamp. We are bound by the German version only.

Description of the Han-Yellock® system

The Han-Yellock® - a special Han® connector

Han-Yellock® is a new product series which retains the core functionality but differs significantly from current size and shape formats. The approach of this series makes many new functions possible, for example:

- ❑ An internal, latched locking mechanism on the hood
- ❑ Multiplies the potentials in the connector with Han-Yellock® modules
- ❑ Usage of Han-Modular® modules with adapter frames
- ❑ Insulators can snap into the front or back walls of the housing
- ❑ Protected Earth contact (PE) in crimp or Quick Lock termination

These new technical features encourage sustained and effective improvements:

When purchasing products –

- ❑ Less article numbers and less inventory,

When planning for the electrical and mechanical layout –

- ❑ Less wiring work within a machine,

During the work flow –

- ❑ Less steps in the work flow and quicker assembly,

And during the after-sales stage –

- ❑ Reduced down times because of the latched locking mechanism and maintenance-friendly design

Thus, the Han-Yellock® offers improved functionality in the form of increased variability, multiplied potential, simplified handling, reduced incidence of errors and maximized safety.

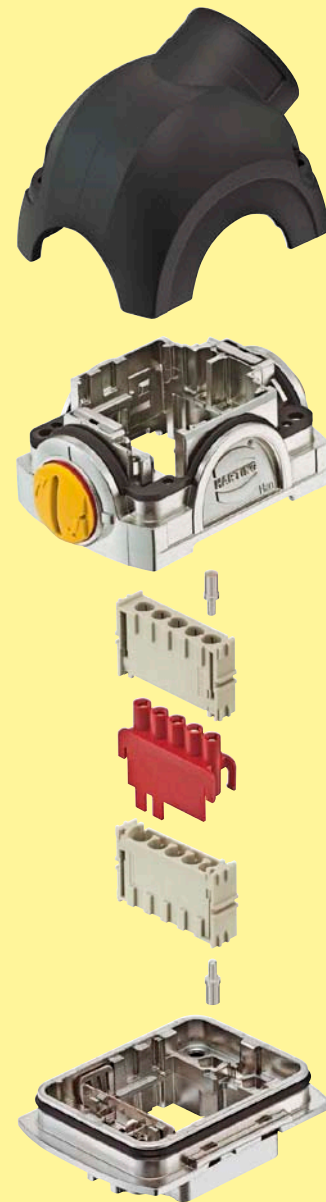

Assembly details

Design overview

The Han-Yellock® interface consists of a housing, bulkhead mounting, on the housing side and a carrier hood with cover on the cable side.

Han-Yellock® offers the following features when assembling components:

- ❑ Han-Yellock® modules require only male crimp contacts.
- ❑ The PE is contacted on the housing; it can be connected with crimp and/or Quick Lock contacts.
- ❑ The Han-Yellock® hoods/housing are not plug-compatible with all other Han® hood/housing series.

The Han-Yellock® system can be used with a variety of insulators and contact inserts in order to establish an interface.

The Locking

The locking ability is a key function of the Han-Yellock®. The function makes connections and disconnections safe, simple and quick – even under harsh industrial conditions.

Main advantages include:

- ❑ Easy handling
- ❑ Resistance to vibrations and shock
- ❑ Protected against accidental opening
- ❑ Compact, space-saving design

Han-Yellock® features a patented internal locking mechanism. The locking takes place as the cable and device sides are simply joined together. A red ring around the perimeter of the push button will be visible if the housing halves do not snap together properly. This ring disappears as soon as the internally protected stainless steel springs snap into place.

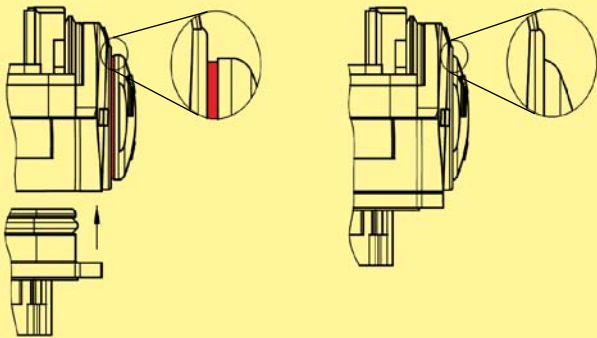

unlocked

locked

This press-button locking also features an integrated blocking function. The locking mechanism can be locked by rotating the button 90°. It is then no longer possible to open the connector.

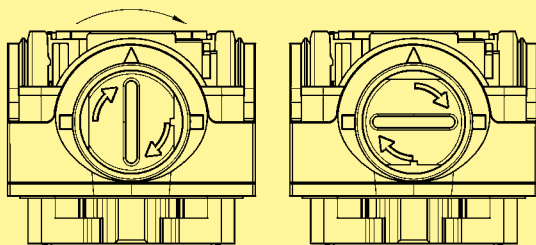

„open“

„blocked“

The press button can be set back to its visually open position only after the button is turned back 90°. It is then possible to release the two housing halves by pressing the snap-in button.

This feature provides an elegant mechanism for preventing an accidental opening of the connector – and no additional components are needed for it.

Han-Yellock® modules

This new product series enables an improved approach and strategy for electrical planning and procurement.

For assembling the Han-Yellock® connector only male crimp contacts are needed. The conduct between the two male contacts is made by multipliers.

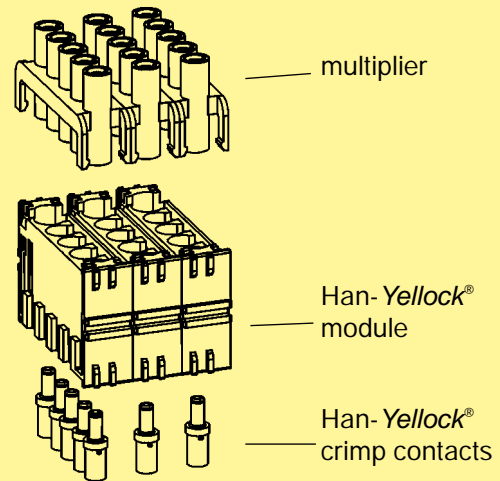

This concept allows a 1:1 wire to wire arrangement and in addition the use of bridges. Two to five contacts can be arranged.

It does not matter if the bridge attachment is inserted on the cable side or the housing side of the connector.

In the past, terminals blocks have been responsible for the function of multiplying potentials. But now this function has been integrated into the connector for a quick, compact and easy-to-service solution.

Inserting the module into the hoods/housing

- ❑ The Han-Yellock® module should only be inserted into the „A“ plug-in position in the metal clamp.

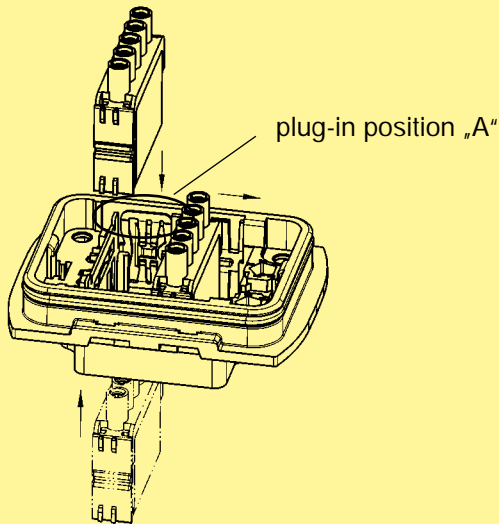

- ❑ The illustration shows the orientation of the module (see arrangement of contacts 1 ... 5).

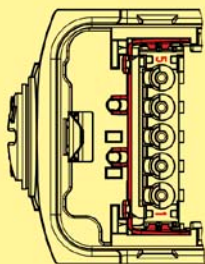

Carrier hood, mating side

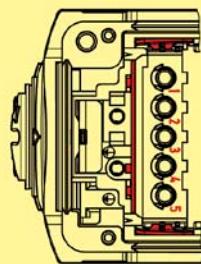

Carrier hood, connection side

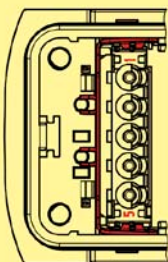

Housing, bulkhead mounting, mating side

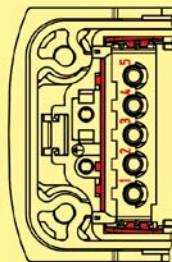

Housing, bulkhead mounting, connection side

- ❑ A distinct click can be heard when the module snaps into position. It is then pushed along the rail to its final position.

The plug-in slots must always be completely filled.

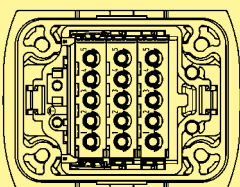

Disassembling the Han-Yellock® module

- ❑ The removal tool (part no. 11 99 000 0001) is required to take out the module.
- ❑ The following illustration shows how to insert the removal tool into the metal clamp. The tool should then be pressed down until it reaches the end stop.
- ❑ The tool is then pulled back and the module comes out of the housing.
- ❑ The removal can be made from the connection side as well as from the mating side.

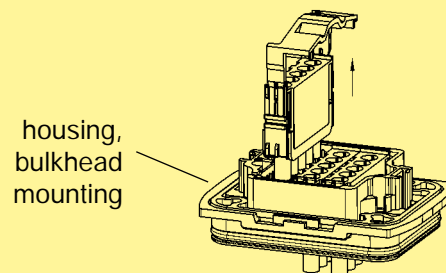
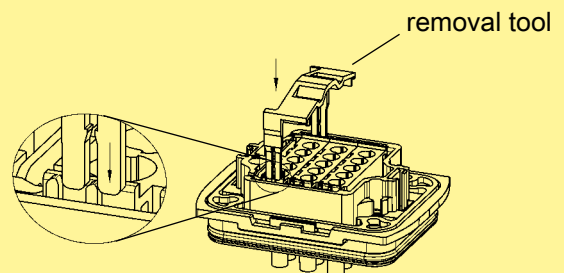

- ❑ The process is identical for both housings, bulkhead mounting, and carrier hoods.
- ❑ The removal tool can be stored on the carrier hood:

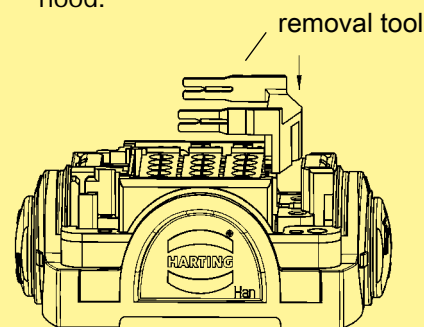

carrier hood

Han-Yellock® adapter frame

Han-Modular® series interfaces can be established using the Han-Yellock® adapter frame. The connection is based on a male/female contact arrangement.

Inserting the adapter frame in the housing:

- ❑ The adapter frame can be snapped into the housing, bulkhead mounting, on the termination side and the mating side (refer to the illustration).
- ❑ The lateral plastic tabs („B“) are pressed into the metal clamps on the housing.
- ❑ The adapter frame then snaps in with a distinctly audible click.

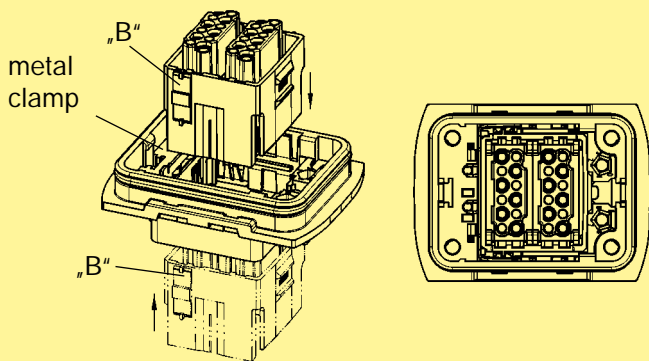

Removal the adapter frame:

- ❑ The removal tool part no. 11 99 000 0001 is required for disassembly.
- ❑ The removal tool is inserted into the metal clamp and pressed down as shown in the following illustration. A screwdriver need also be placed into the notch in the housing.
- ❑ The removal tool should then be pulled outwards to remove the adapter frame from the housing.
- ❑ The removal can be made from the termination side as well as from the mating side.
- ❑ The process is identical for both housings, bulkhead mounting, and carrier hoods.

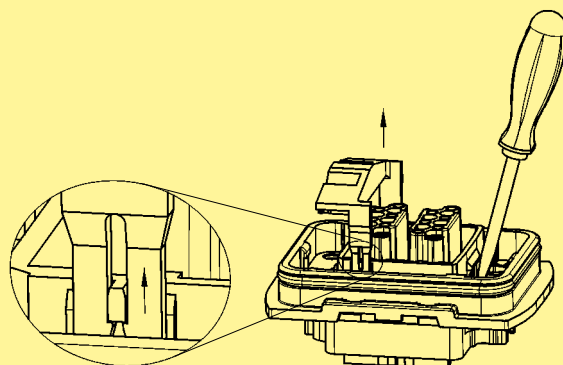
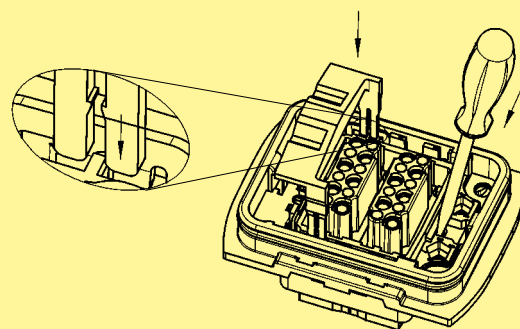

Han-Yellock® Protection covers

Protection cover function

To protect the insert against dust and water it is possible to use a Han-Yellock® protection cover.

The protection cover comes with a metal bearing pedestal and can be installed during initial or retrofit installation.

The Han-Yellock® design offer the possibility to snap in the pedestal either on the left or on the right side of the housing.

The direction of the cover movement can flip without turning the housing and inserts.

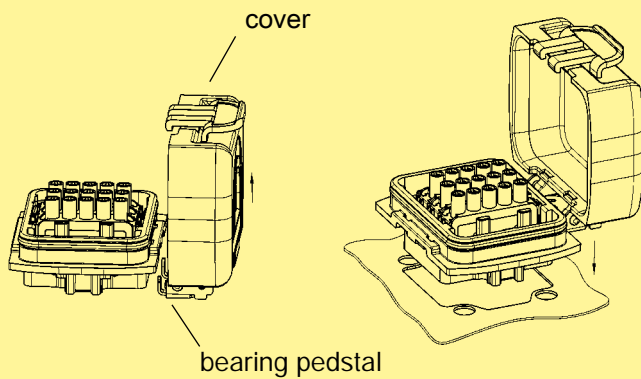

Han-Yellock® Ground terminal

Ground terminal assembly

On the housing side ground terminals can be used.

After placing the frame deeply inside the housing slots the housing will be fixed to the panel leading to solid mounting of the complete set.

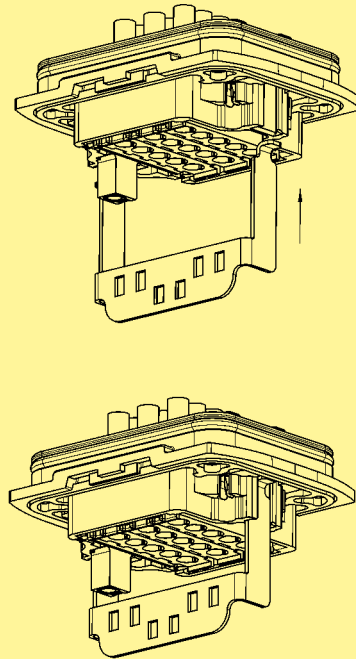

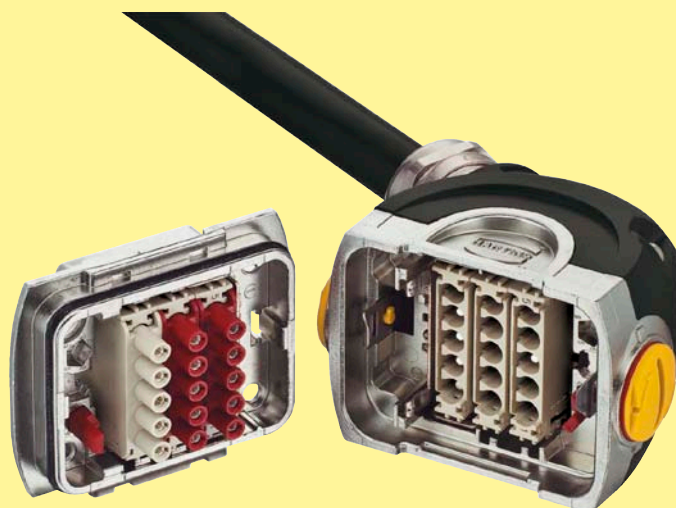

Han-Yellock® hoods/housings



page 14

Han-Yellock® modules

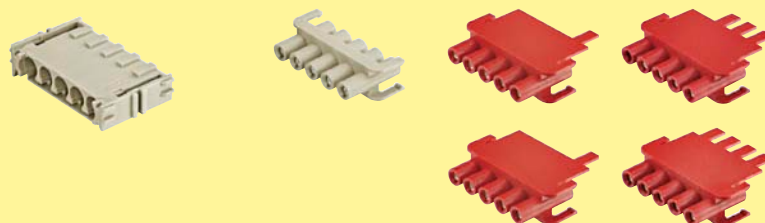

page 20

Han-Yellock® adapter frames



page 24

Features

- Two-part hoods for easy wiring and testing
- High robustness via an internal locking mechanism
- Earthed contacts PE in crimped or Quick Lock termination technique
- Protection cover retrofit on housing side

Technical Characteristics

Shell

Material	aluminium
Surface	powder-coated
Locking element	stainless steel
Limiting temperatures	-40 °C ... +125 °C
Degree of protection acc. to DIN EN 60 529 when locking	IP 67
Tightening torque	
M4 fixing screw	1.2 Nm

Carrier hoods and Housings, bulkhead mounting

Number of Han-Yellock® modules	
Han-Yellock® 30	3
Han-Yellock® 60	6
Material	Zinc die-cast
Surface	
Locking element	PA / stainless steel
Hoods/Housings sealing	NBR
Limiting temperatures	-40 °C ... +125 °C
Un-/Locking temperature	-10 °C ... +85 °C
Degree of protection acc. to DIN EN 60 529 when locking	IP 67
Mechanical working life	
- mating cycles	500
PE wire	
termination gauge	≤ 4 mm ²
Tightening torque	
M4 fixing screw	≥ 1 Nm
panel fastener	2.3 Nm

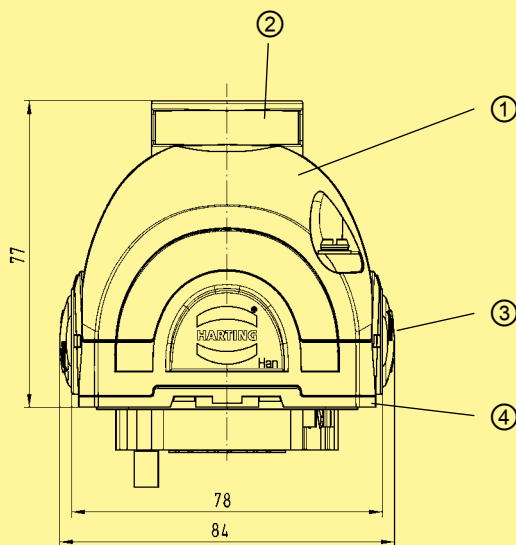



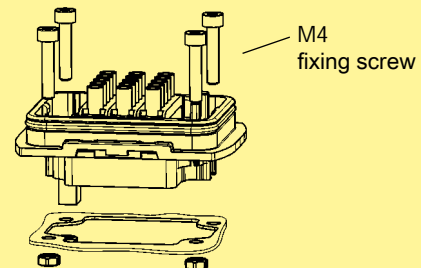
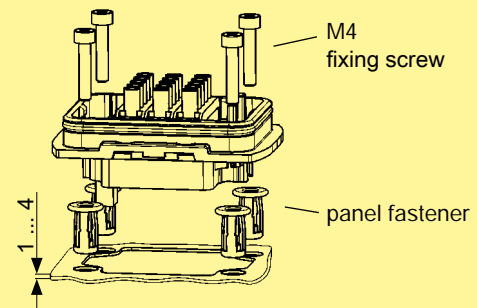



- ① Shell with top entry
- ② cable entry M25
- ③ Carrier hood with push button release
- ④ Housing, bulkhead mounting



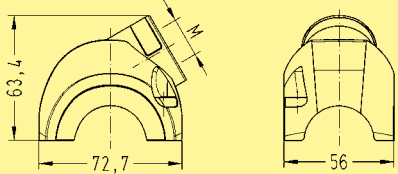

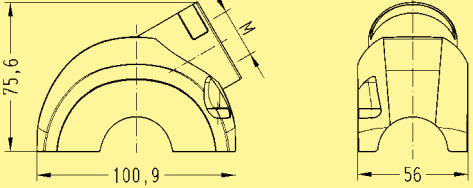

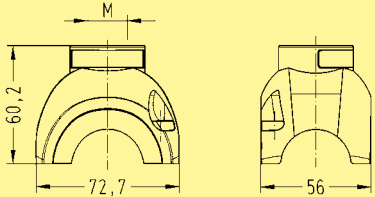
Protection covers

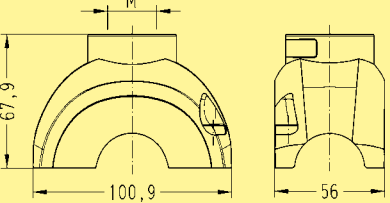
Material	PA
Hoods/Housings sealing	NBR
Degree of protection acc. to DIN EN 60 529 when locking	IP 67
Flammability acc. to UL 94	V0

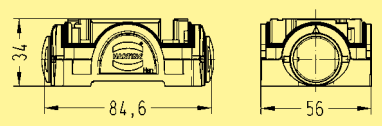
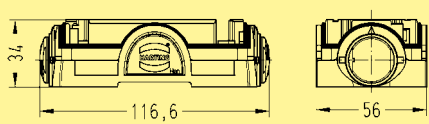

Han-Yellok® Hoods

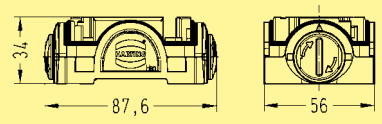
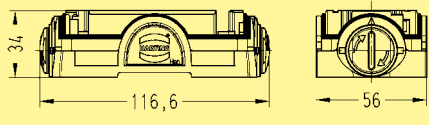
Identification	Part number	Cable entry metric	Drawing	Dimensions in mm		
Shell side entry Han-Yellok® 30 Han-Yellok® 60		11 12 300 1500	M20		56	
		11 12 300 1501	M25			
		11 12 300 1502	M32			
		11 12 600 1501	M25		56	
		11 12 600 1502	M32			
		11 12 600 1503	M40			
	Shell top entry Han-Yellok® 30 Han-Yellok® 60		11 12 300 1400	M20		56
			11 12 300 1401	M25		
			11 12 300 1402	M32		
		11 12 600 1401	M25		56	
		11 12 600 1402	M32			
		11 12 600 1403	M40			

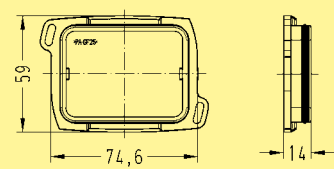
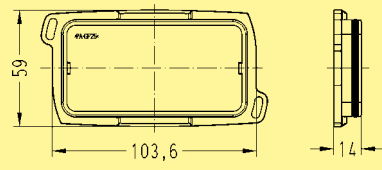
Han-Yellock® Hoods

Identification	Part number	Cable entry metric	Drawing	Dimensions in mm
Carrier hood plain push button 	Han-Yellock® 30	-		
	Han-Yellock® 60	-		
Carrier hood push button, slot 	Han-Yellock® 30	-		
	Han-Yellock® 60	-		
Protection cover for carrier hoods with cord 	Han-Yellock® 30			
	Han-Yellock® 60			

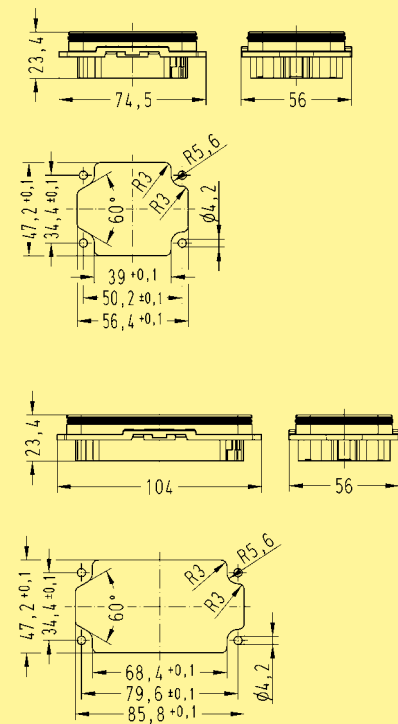
Han-Yellok® Housings

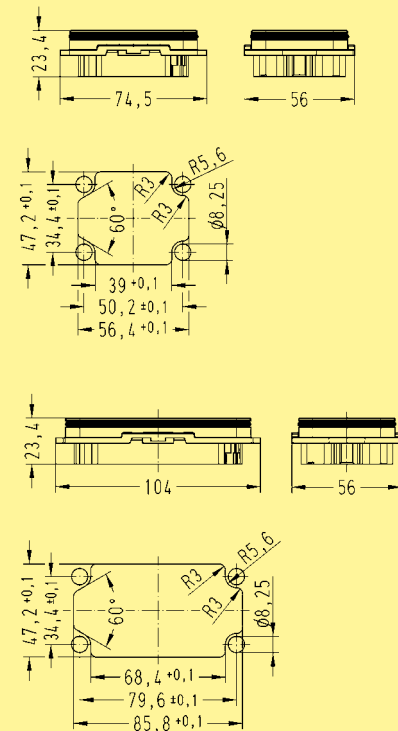
Identification	Part number	Cable entry metric	Drawing	Dimensions in mm
<p>Housing, bulkhead mounting</p>  <p>Han-Yellok® 30</p> <p>Han-Yellok® 60</p>	<p>11 12 300 0301</p> <p>11 12 600 0301</p>			
<p>Housing, bulkhead mounting</p>  <p>Han-Yellok® 30</p> <p>Set consists of Han-Yellok® 30 housing, bulkhead mounting and panel fastener</p> <p>Han-Yellok® 60</p> <p>Set consists of Han-Yellok® 60 housing, bulkhead mounting and panel fastener</p>	<p>11 12 300 0302</p> <p>11 12 600 0302</p>			

Han-Yellock® Housings

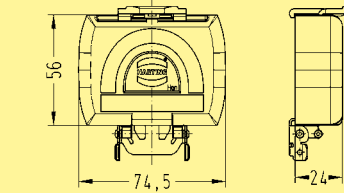
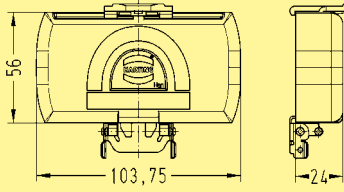
Identification	Part number	Cable entry metric	Drawing	Dimensions in mm
<p>Protection cover for housings, bulkhead mounting</p>  <p>Han-Yellock® 30</p> <p>Set consists of protection cover and bearing pedestal</p> <p>Han-Yellock® 60</p> <p>Set consists of protection cover and bearing pedestal</p>	<p>11 12 300 5401</p> <p>11 12 600 5401</p>		 	



Features

- Snap-in assembly from mating side and from termination side
- Wiring with male contacts only
- Bus bar within bridge attachments
- Finger safe design
- Fast and tool-less assembly

Placement for Han-Yellock® 30
with 3 Han-Yellock® modules

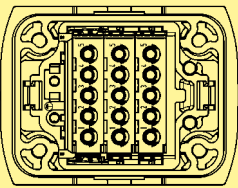

Placement for Han-Yellock® 60
with 6 Han-Yellock® modules

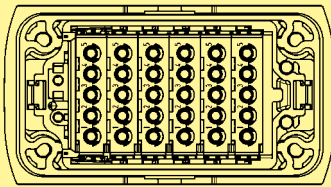

Current carrying capacity

The current carrying capacity of the connectors is limited by the thermal load capability of the contact element material including the connections and the insulating parts. The derating curve is therefore valid for currents which flow constantly (non-intermittent) through each contact element of the connector evenly, without exceeding the allowed maximum temperature.

Measuring and testing techniques according to DIN EN 60 512-5

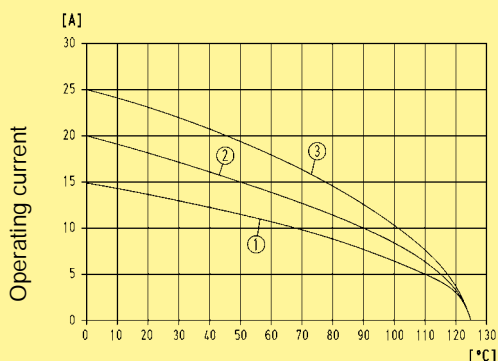

Ambient temperature

① Wire gauge: 1.5 mm²

② Wire gauge: 2.5 mm²

③ Wire gauge: 4.0 mm²

for connector with 3 Han-Yellock® modules, fully loaded
(multiplier 1:1)

Technical Characteristics

Specifications	DIN EN 60 664-1 DIN EN 61 984
----------------	----------------------------------

Modules

Electrical data acc. to DIN EN 61 984	20 A 500 V 6 kV 3
Rated current	20 A
Rated voltage	500 V
Rated impulse voltage	6 kV
Pollution degree	3
Pollution degree 2 also	20 A 690 V 8 kV 2

Insulation resistance	≥ 10 ¹⁰ Ω
Material	Polycarbonate
Limiting temperatures	-40 °C ... +125 °C
Flammability acc. to UL 94	V0
Mechanical working life - mating cycles	≥ 500

Contacts

Material	copper alloy
Surface	
- hart-silver plated	3 μm Ag
Contact resistance	≤ 2 mΩ
Crimp terminal	
- wire gauge ¹⁾	0.14 ... 4 mm ²
- AWG	26 ... 12
- Stripping length	6.5 mm

Number of contacts

5

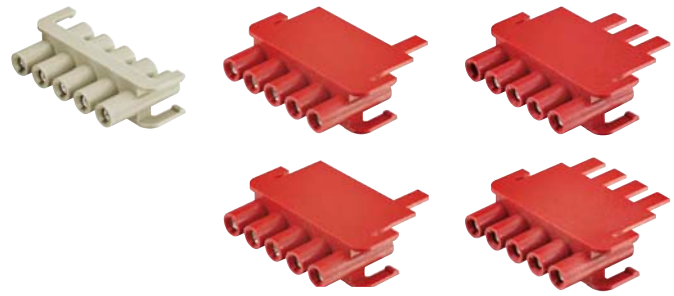

Identification

Part number

Drawing

Dimensions in mm

Han-Yellock® multiplier

multiplier 1:1



11 05 105 2801

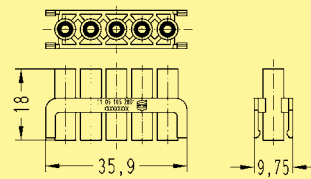

multiplier 2:3



11 05 105 2802

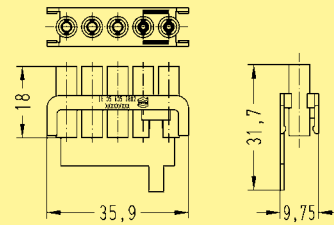

multiplier 3:2



11 05 105 2803

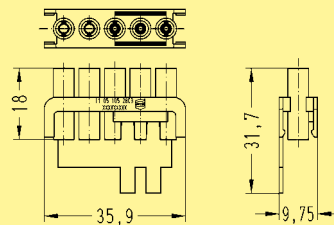

multiplier 4:1



11 05 105 2804

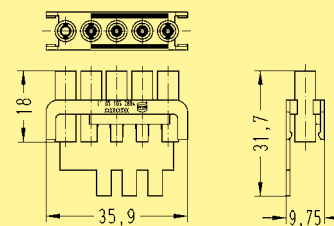

multiplier 5:0



11 05 105 2805

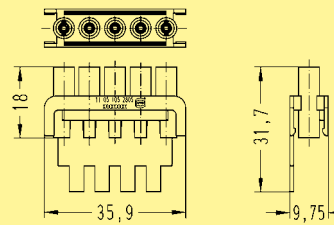

Features

- Suitable for Han-Modular® modules up to 4 mm²
- Snap-in functionality from mating side and from termination side

Technical Characteristics

Specifications	DIN EN 60 664-1 DIN EN 61 984
----------------	----------------------------------

Adapter frames

Number of modules	max. 2
Material	Polycarbonate
Flammability acc. to UL 94	V0

Mounting

- The adapter frame can be snapped into the housing, bulkhead mounting, on the connection side and the plug-in side (refer to the illustration).
- The lateral plastic tabs („B“) are pressed into the metal clamps on the housing.
- The adapter frame then snaps in with a distinctly audible click.

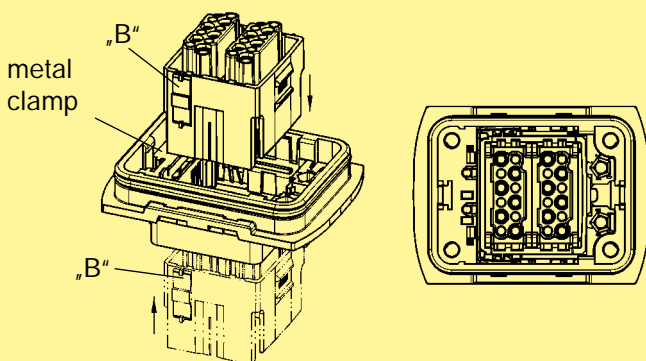



Removal

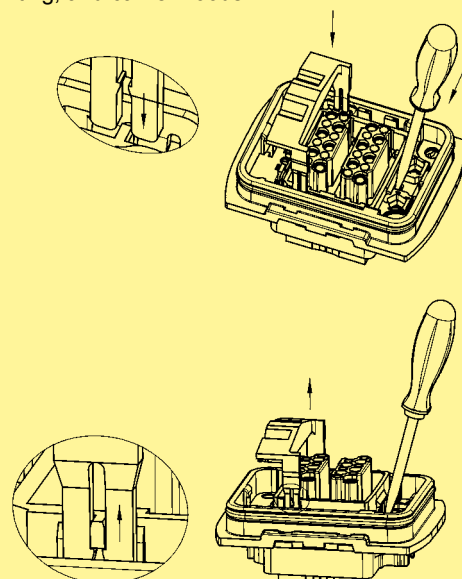

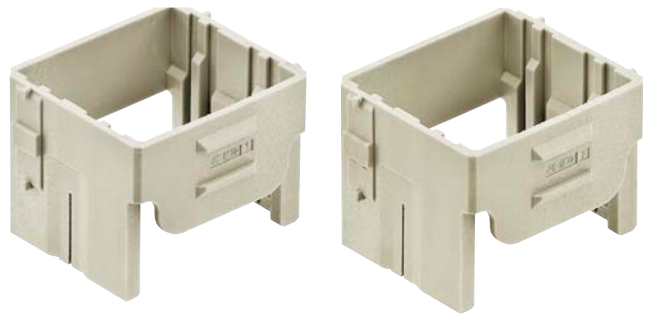

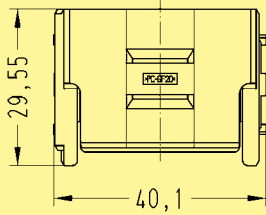
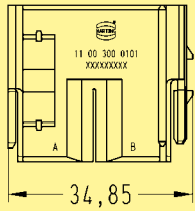

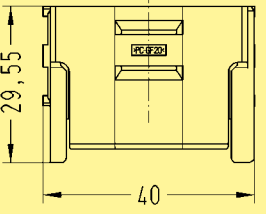
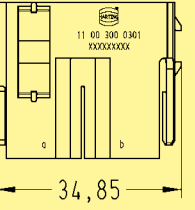





- The removal tool part no. 09 99 000 0001 is required for removal.
- The removal tool is inserted into the metal clamp and pressed down as shown in the following illustration. A screwdriver can also be placed into the notch in the housing.
- The removal tool should then be pulled outwards to remove the adapter frame from the housing.
- The removal can be made from the connection side as well as from the plug-in side.
- The process is identical for both housings, bulkhead mounting, and carrier hoods.



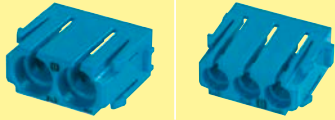



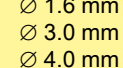





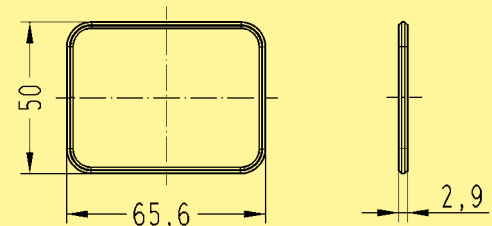
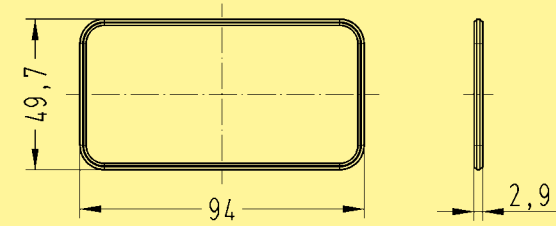

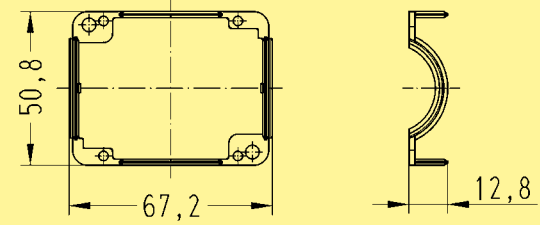
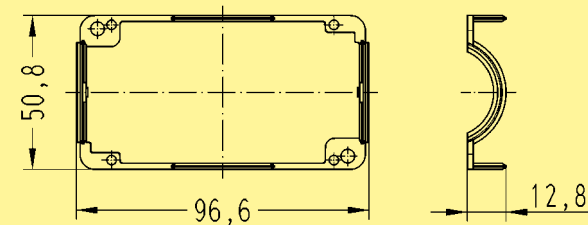

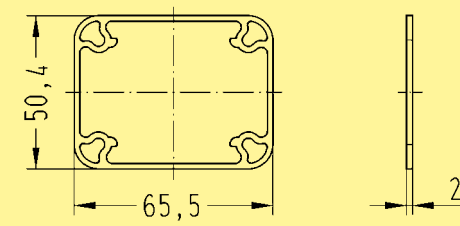
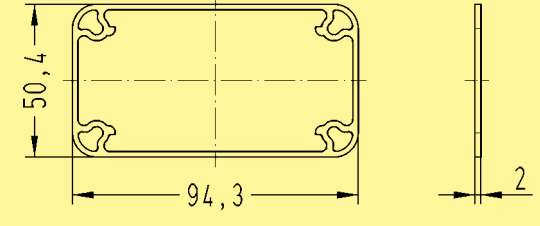

Identification	Part number	Drawing	Dimensions in mm
<p>Han-Yellock® 30 Adapter frame</p> <p>for carrier hoods</p> 	<p>11 00 300 0101</p>		
<p>for housings, bulkhead mounting</p> 	<p>11 00 300 0301</p>		

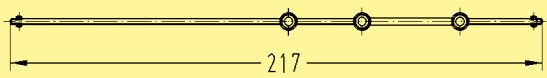
Modules	Han® CC Protected module	Han® CD module	Han E® module	Han® EE module
Number of contacts	4	3 / 4	6	8
Termination	Crimp terminal	Crimp terminal	Crimp terminal	Crimp terminal
Rated current	40 A	40 A / 10 A	16 A	16 A
Rated voltage	830 V	830 V / 830 V	500 V	400 V
Wire gauge	1.5 - 6 mm ²	1.5 - 6 mm ² / 0.14 - 2.5 mm ²	0.5 - 4 mm ²	0.5 - 4 mm ²
Modules	Han® EE module	Han E® Protected module	Han® EEE module	Han® ES module
Number of contacts	8	6	20	5
Termination	Quick Lock terminal	Crimp terminal	Crimp terminal	Cage-clamp terminal
Rated current	16 A	16 A	16 A	16 A
Rated voltage	400 V	830 V	500 V	400 V
Wire gauge	0.5 - 2.5 mm ²	0.5 - 4 mm ²	0.5 - 4 mm ²	0.14 - 2.5 mm ²
Modules	Han DD® module	Han® DDD module	Han® High Density module	Han® D-Sub module
Number of contacts	12	17	25	9
Termination	Crimp terminal	Crimp terminal	Crimp terminal	Crimp terminal
Rated current	10 A	10 A	4 A	5 A
Rated voltage	250 V	160 V	50 V	50 V
Wire gauge	0.14 - 2.5 mm ²	0.14 - 2.5 mm ²	0.08 - 0.52 mm ²	0.08 - 0.52 mm ²
Modules	Han® USB module	Han® FireWire module	Han® RJ45 module	Han® GigaBit module
Number of contacts	4	6	8	8
Termination	USB 2.0	IEEE 1394	Ethernet Cat. 5e	Ethernet Cat. 6

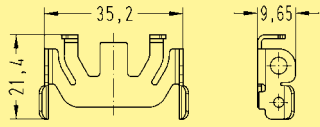
Modules	Han-Quintax® module				Han® Multi Contact module	
Number of contacts	2				4	
Contacts	 <p>Quintax contact 4 + shielding</p>	 <p>High Density Quintax contact 8 + shielding</p>	 <p>Han D° Coax contact 1 + shielding</p> <p>75 Ω</p>	 <p>Han E° Coax contact 1 + shielding</p> <p>50 Ω</p>	 <p>F.O. contact</p> <p>Multimode F.O. HCS®*/PCF F.O. 1 mm POF</p>	 <p>Coaxial contact</p> <p>50 Ω RG 174 75 Ω RG 179 50 Ω RG 58</p>
Modules	Han® Pneumatic module		Han® SC module			
Number of contacts	2		3		4	
Contacts	 <p>Pneumatic contacts</p>  <p>Ø 6.0 mm</p>		 <p>SC contact</p>  <p>Ø 1.6 mm</p>  <p>Ø 3.0 mm</p>  <p>Ø 4.0 mm</p>			

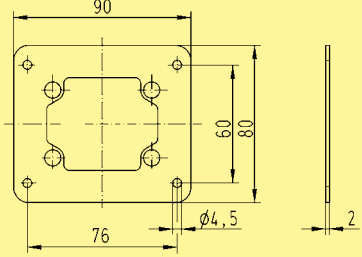
* HCS®=Hard Clad Silica (is registered trade mark of SpecTran Corporation)

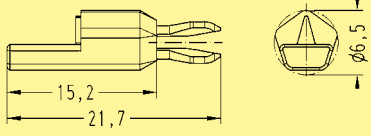
Identification	Part number	Drawing	Dimensions in mm
<p>Han-Yellock® Profile seal</p>  <p>for Han-Yellock® 30</p>	11 00 300 9501		
<p>for Han-Yellock® 60</p>	11 00 600 9501		
<p>Han-Yellock® Seal for carrier hoods</p>  <p>for Han-Yellock® 30</p>	11 00 300 9502		
<p>for Han-Yellock® 60</p>	11 00 600 9502		
<p>Han-Yellock® Gasket</p>  <p>for Han-Yellock® 30</p>	11 00 300 9503		
<p>for Han-Yellock® 60</p>	11 00 600 9503		

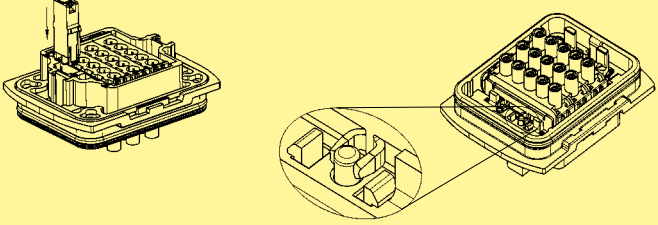
Identification	Part number	Drawing	Dimensions in mm
<p>Han-Yellock® Fixing cord for protection cover cable side</p> 	11 00 000 9507		
<p>Han-Yellock® Bearing pedestal</p> 	11 00 000 9506		
<p>Han-Yellock® 30 Adapter plate circular 68 mm punch to Han-Yellock® panel cut out</p> 	11 00 300 9601		
<p>Han-Yellock® Identification sticks</p>	11 00 000 9601		
<p>Han-Yellock® Coding pins Set of 8 coding pins</p> 	11 00 000 9501		
<p>PE Contact chamber with Quick Lock termination</p> 	11 05 001 2601		

Identification	Part number	Drawing	Dimensions in mm
<p>BUCHANAN crimping tool</p> <p>Locator Han-<i>Yellock</i>[®]</p> <p>Multiple crimping tool depth adjustment gauge</p>	<p>09 99 000 0001</p> <p>09 99 000 0342</p> <p>09 99 000 0379</p>	<p>Wire gauge 0.14 ... 4 mm²</p> <p>Wire gauge 0.14 ... 0.37 mm² Ø 1.00 0.5 ... 1.0 mm² Ø 1.55 1.5 ... 2.5 mm² Ø 1.80 3.0 ... 4.0 mm² Ø 2.00</p>	<p>order separately</p>
<p>HARTING crimping tool Han D[®], Han E[®], Han[®] C locator included</p> <p>Locator Han-<i>Yellock</i>[®]</p>	<p>09 99 000 0110</p> <p>09 99 000 0341</p>	<p>Wire gauge 0.5 ... 4 mm²</p>	
<p>HARTING Service crimping tool Han D[®], Han E[®] locator included</p> <p>Locator Han-<i>Yellock</i>[®]</p>	<p>09 99 000 0021</p> <p>09 99 000 0343</p>	<p>Wire gauge 0.14 ... 1.5 mm²</p>	
<p>Removal tool for Han-<i>Yellock</i>[®] modules and frames</p>	<p>11 99 000 0001</p>		
<p>Removal tool for crimp contacts</p>	<p>09 99 000 0319</p>	<p>This removal tool is necessary if contacts are to be replaced in the insert. The tool is inserted from the wiring side until a stop is noticeable. The wire with the crimp contact can then be pulled out from the same side of the insert.</p>	
<p>Panel Punch panel cut out tool panel thickness steel: ≤ 2.5 mm stainless steel: ≤ 2.0 mm for hydraulic pump punch force: ≥ 60 kN thread: 3/4" UNF</p> <p>for Han-<i>Yellock</i>[®] 30</p>	<p>11 99 300 0001</p>		

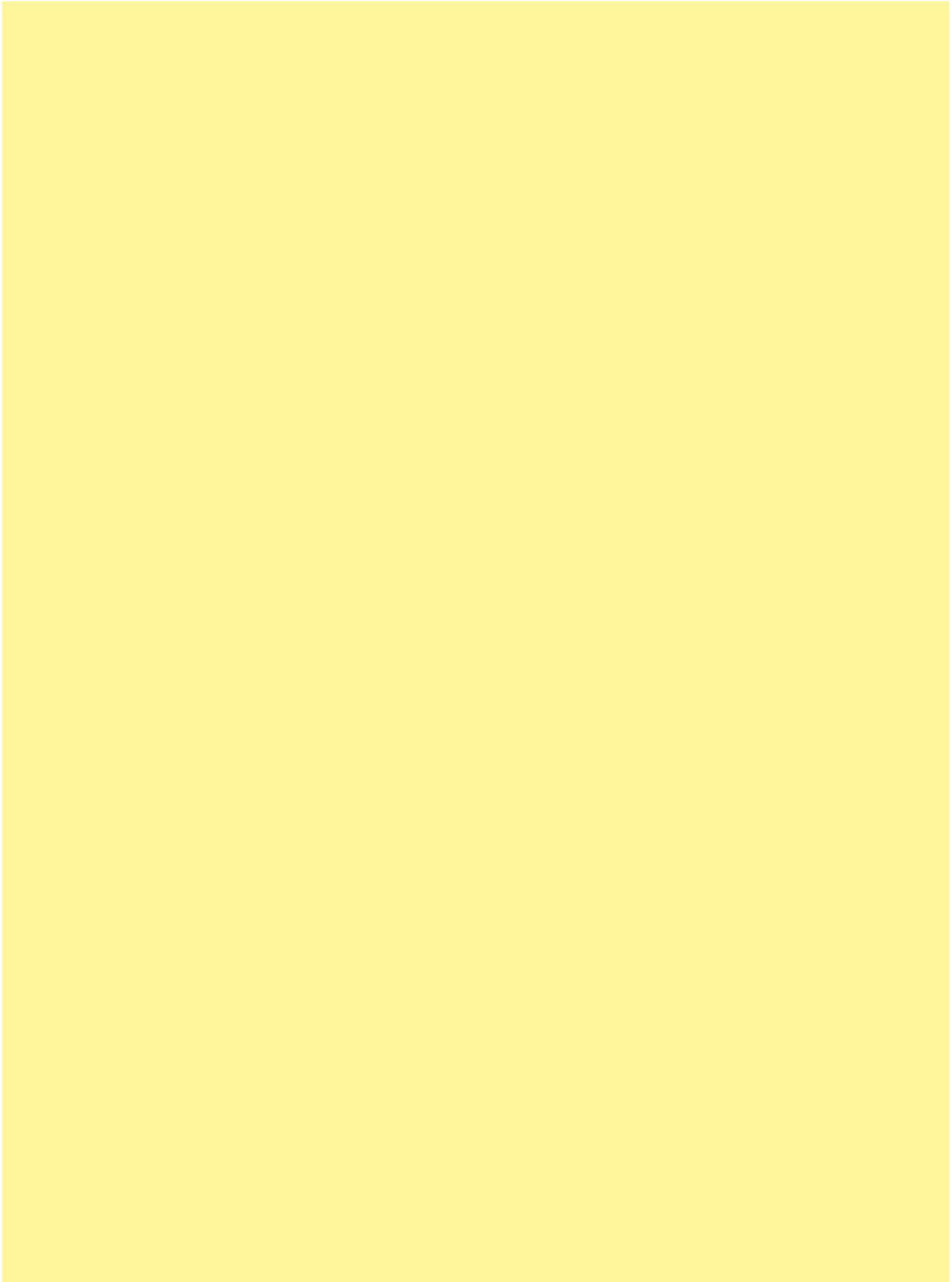

Part number	Page	Part number	Page
09 99 000 0001	30	11 12 300 0100	16
09 99 000 0021	30	11 12 300 0110	16
09 99 000 0110	30	11 12 300 0301	17
09 99 000 0319	21	11 12 300 0302	17
09 99 000 0319	30	11 12 300 1400	15
09 99 000 0341	30	11 12 300 1401	15
09 99 000 0342	30	11 12 300 1402	15
09 99 000 0343	30	11 12 300 1500	15
09 99 000 0379	30	11 12 300 1501	15
		11 12 300 1502	15
		11 12 300 5401	18
11 00 000 9501	29	11 12 300 5451	16
11 00 000 9506	29		
11 00 000 9507	29	11 12 600 0100	16
11 00 000 9601	29	11 12 600 0101	16
		11 12 600 0301	17
11 00 300 0101	25	11 12 600 0302	17
11 00 300 0301	25	11 12 600 1401	15
11 00 300 9501	28	11 12 600 1402	15
11 00 300 9502	28	11 12 600 1403	15
11 00 300 9503	28	11 12 600 1501	15
11 00 300 9601	29	11 12 600 1502	15
		11 12 600 1503	15
11 00 600 9501	28	11 12 600 5401	18
11 00 600 9502	28	11 12 600 5451	16
11 00 600 9503	28		
		11 99 000 0001	30
		11 99 300 0001	30
11 05 000 6101	21		
11 05 000 6102	21		
11 05 000 6103	21		
11 05 000 6104	21		
11 05 000 6105	21		
11 05 000 6106	21		
11 05 000 6107	21		
11 05 000 6108	21		
11 05 001 2601	29		
11 05 105 2801	23		
11 05 105 2802	23		
11 05 105 2803	23		
11 05 105 2804	23		
11 05 105 2805	23		
11 05 105 3001	21		

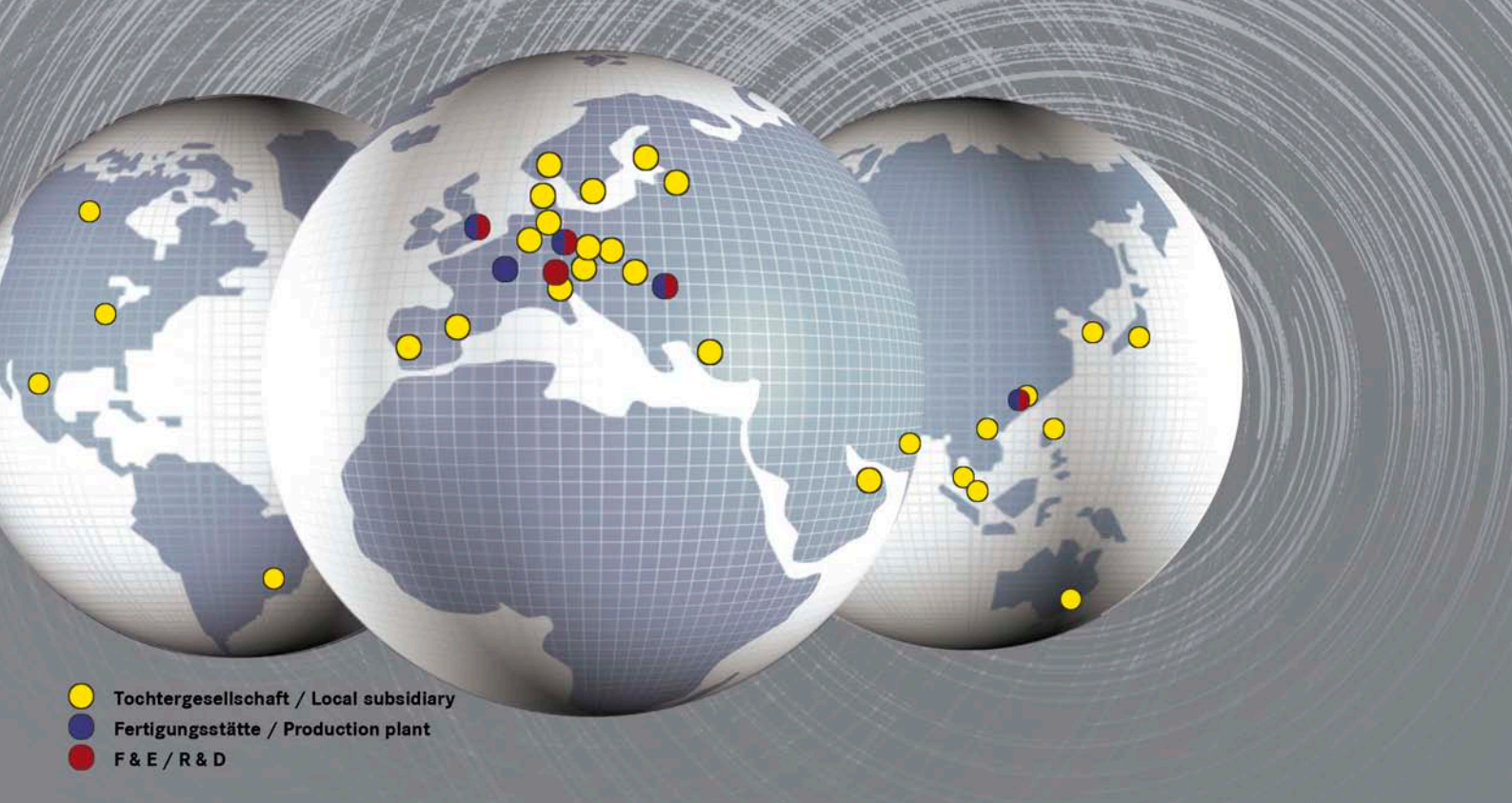

Sales Network – worldwide



Albania

see Eastern Europe

Argentina

see Brazil

Armenia

see Eastern Europe

Australia

HARTING Pty Ltd
Suite 11 / 2 Enterprise Drive
Bundoora 3083, AUS-Victoria
Phone +61 9466 7088
Fax +61 9466 7099
au@HARTING.com
www.HARTING.com

Austria

HARTING Ges.m.b.H.
Deutschstraße 19, A-1230 Wien
Phone +431 6162121
Fax +431 6162121-21
at@HARTING.com
www.HARTING.at

Azerbaijan

see Eastern Europe

Belarus

see Eastern Europe

Belgium

HARTING N.V./S.A.
Z.3 Doornveld 23, B-1731 Zellik
Phone +32 2 466 0190
Fax +32 2 466 7855
be@HARTING.com
www.HARTING.be

Bosnia and Herzegovina

see Eastern Europe

Brazil

HARTING Ltda.
Av. Dr. Lino de Moraes
Pq. Jabaquara, 255
CEP 04360-001 – São Paulo –
SP – Brazil
Phone +55 11 5035 0073
Fax +55 11 5034 4743
br@HARTING.com
www.HARTING.com.br

Brunei

see Singapore

Bulgaria

see Eastern Europe

Canada

see USA

China

Zhuhai HARTING Limited
Shanghai branch
Room 5403, HK New World Tower
300 Huai Hai Road (M.)
Shanghai 200021, China
Phone +86 21 6386 2200
Fax +86 21 6386 8636
cn@HARTING.com
www.HARTING.com.cn

Croatia

see Eastern Europe

Czech Republic

HARTING s.r.o.
Mlýnská 2, CZ-160 00 Praha 6
Phone +420 220 380 460
Fax +420 220 380 461
cz@HARTING.com
www.HARTING.cz

Denmark

HARTING ApS
Hjulmagervej 4a
DK - 7100 Vejle
Phone +45 70 25 00 32
Fax +45 75 80 64 99
dk@HARTING.com
www.HARTING.com

Eastern Europe

HARTING Eastern Europe GmbH
Bamberger Straße 7
D-01187 Dresden
Phone +49 351 4361 760
Fax +49 351 436 1770
Eastern.Europe@HARTING.com
www.HARTING.com

Estonia

see Eastern Europe

Finland

HARTING Oy
Teknobulevardi 3-5, PL 35
FI-01530 Vantaa
Phone +358 9 350 87 300
Fax +358 9 350 87 320
fi@HARTING.com
www.HARTING.fi

France

HARTING France
181 avenue des Nations, Paris Nord 2
BP 66058 Tremblay en France
F-95972 Roissy Charles de Gaulle
Cédex
Phone +33 1 4938 3400
Fax +33 1 4863 2306
fr@HARTING.com
www.HARTING.fr

Germany

HARTING Deutschland GmbH & Co. KG
P.O. Box 2451, D-32381 Minden
Simeons carré 1, D-32427 Minden
Phone +49 571 8896 0
Fax +49 571 8896 282
de@HARTING.com
www.HARTING-Deutschland.de

Germany (Office)

HARTING Deutschland GmbH & Co. KG
Blankenauer Straße 99
D-09113 Chemnitz
Phone +49 0371 429211
Fax +49 0371 429222
de@HARTING.com
www.HARTING-Deutschland.de

Georgia

see Eastern Europe

Great Britain

HARTING Ltd., Caswell Road
Brackmills Industrial Estate
GB-Northampton, NN4 7PW
Phone +44 1604 827 500
Fax +44 1604 706 777
gb@HARTING.com
www.HARTING.co.uk

Hong Kong

HARTING (HK) Limited
Regional Office Asia Pacific
3512 Metroplaza Tower 1
223 Hing Fong Road
Kwai Fong, N. T., Hong Kong
Phone +852 2423 7338
Fax +852 2480 4378
ap@HARTING.com
www.HARTING.com.hk

Hungary

HARTING Magyarország Kft.
Fehérvári út 89-95, H-1119 Budapest
Phone +36 1 205 34 64
Fax +36 1 205 34 65
hu@HARTING.com
www.HARTING.hu

Iceland

Smith & Norland, Nóatún 4
IS – 105 Reykjavík
Phone +354 520 3000
Fax +354 520 3011
olaf@sminor.is, www.sminor.is

India

HARTING India Private Limited
No. D, 4th Floor, 'Doshi Towers'
No. 156 Poonamallee High Road
Kilpauk, Chennai 600 010
Tamil Nadu, India
Phone +91 44 435604 15 / 416
Fax +91 44 435604 17
in@HARTING.com
www.HARTING.com

Indonesia

see Malaysia

Israel

COMTEL
Israel Electronic Solutions Ltd.
Bet Hapamon, 20 Hataas st.
P.O.Box 66
Kefar-Saba 44425
Phone +972-9-7677240
Fax +972-9-7677243
sales@comtel.co.il
www.comtel.co.il

Italy

HARTING SpA
Via Dell' Industria 7
I-20090 Vimodrone (Milano)
Phone +39 02 250801
Fax +39 02 2650 597
it@HARTING.com
www.HARTING.it

Japan

HARTING K. K.
Yusen Shin-Yokohama 1 Chome Bldg., 2F
1-7-9, Shin-Yokohama, Kohoku-ku
Yokohama 222-0033 Japan
Phone +81 45 476 3456
Fax +81 45 476 3466
jp@HARTING.com
www.HARTING.co.jp

Kazakhstan

see Eastern Europe

Kirghizia

see Eastern Europe

Korea (South)

HARTING Korea Limited
#308 Yatap Leaders Building, 342-1
Yatap-dong, Bundang-gu
Sungnam-City, Kyunggi-do
463-828, Republic of Korea
Phone +82 31 781 4615
Fax +82 31 781 4616
kr@HARTING.com
www.HARTING.com.cn/kr

Kosovo

see Eastern Europe

Latvia

see Eastern Europe

Lithuania

see Eastern Europe

Macedonia

see Eastern Europe

Malaysia (Office)

HARTING Singapore Pte Ltd
Malaysia Branch
11-02 Menara Amcorp
Jln. Persiaran Barat
46200 PJ, Sel. D. E., Malaysia
Phone +60 3 / 7955 6173
Fax +60 3 / 7955 5126
sg@HARTING.com

Montenegro

see Eastern Europe

Netherlands

HARTING B.V.
Larenweg 44
NL-5234 KA 's-Hertogenbosch
Postbus 3526
NL-5203 DM 's-Hertogenbosch
Phone +31 736 410 404
Fax +31 736 440 699
nl@HARTING.com
www.HARTINGbv.nl

New Zealand

see Australia

Norway

HARTING A/S
Østensjøveien 36, N-0667 Oslo
Phone +47 22 700 555
Fax +47 22 700 570
no@HARTING.com
www.HARTING.no

Philippines

see Malaysia

Poland

HARTING Polska Sp. z o. o.
ul. Kamieńskiego 201-219
PL-51-126 Wrocław
Phone +48 71 352 81 71
Fax +48 71 320 74 44
pl@HARTING.com
www.HARTING.pl

Portugal

HARTING Iberia, S. A.
Avda. Josep Tarradellas 20-30 4º 6a
E-08029 Barcelona
Phone +351 219 673 177
Fax +351 219 678 457
es@HARTING.com
www.HARTING.es/pt

Republic of Moldova

see Eastern Europe

Romania

HARTING Romania SCS
Europa Unita str. 21
550018-Sibiu, Romania
Phone +40 369-102 671
Fax +40 369-102 622
ro@HARTING.com
www.HARTING.com

Russia

HARTING ZAO
Maliy Sampsoniyevsky prospect 2A
194044 Saint Petersburg, Russia
Phone +7 812 327 6477
Fax +7 812 327 6478
ru@HARTING.com
www.HARTING.ru

Serbia

see Eastern Europe

Singapore

HARTING Singapore Pte Ltd.
25 International Business Park
#02-06 German Centre
Singapore 609916
Phone +65 6225 5285
Fax +65 6225 9947
sg@HARTING.com
www.HARTING.com

Slovakia

HARTING s.r.o.
Sales office Slovakia
Povázska 2, SK - 940 67 Nové Zámky
Phone +421 356-493 993
Fax +421 356-402 114
sk@HARTING.com
www.HARTING.sk

Slovenia

see Eastern Europe

South Africa

HellermannTyton Pty Ltd.
Private Bag X158 Rivonia 2128
34 Milky Way Avenue
Linbro Business Park 2065, Johannesburg
Phone +27(0)11879-6600
Fax +27(0)11879-6606
sales.jhb@hellermann.co.za

Spain

HARTING Iberia S.A.
Avda. Josep Tarradellas 20-30 4º 6ª
E-08029 Barcelona
Phone +34 93 363 84 75
Fax +34 93 419 95 85
es@HARTING.com
www.HARTING.es

Sweden

HARTING AB
Gustavslundsvägen 141 B 4tr
S-167 51 Bromma
Phone +46 8 445 7171
Fax +46 8 445 7170
se@HARTING.com
www.HARTING.se

Switzerland

HARTING AG
Industriestrasse 26
CH-8604 Volketswil
Phone +41 44 908 20 60
Fax +41 44 908 20 69
ch@HARTING.com
www.HARTING.ch

Taiwan

HARTING R.O.C. Limited
Room 1, 5/F
495 GuangFu South Road
RC-110 Taipei, Taiwan
Phone +886 227 586 177
Fax +886 227 587 177
tw@HARTING.com
www.HARTING.com.tw

Tajikistan

see Eastern Europe

Thailand

see Malaysia

Turkey

HARTING TURKEI Elektronik Ltd. Şti.
Barbaros Mah. Dereboyu Cad.
Fesleğen Sok.
Uphill Towers, A-1b Kat:8 D:45
34746 Ataşehir, İstanbul
Phone +90 216 688 81 00
Fax +90 216 688 81 01
ahmetcan.ayan@HARTING.com
www.HARTING.com.tr

Turkmenistan

see Eastern Europe

Ukraine

see Eastern Europe

USA

HARTING Inc. of North America
1370 Bowes Road
USA-Elgin, Illinois 60123
Phone +1 (877) 741-1500 (toll free)
Fax +1 (866) 278-0307 (Inside Sales)
Fax +1 (847) 717-9430 (Sales and Marketing)
us@HARTING.com
www.HARTING-USA.com

Uzbekistan

see Eastern Europe

Vietnam (Office)

HARTING Singapore Pte Ltd
Hanoi Representative Office
Suite 518, 5th Floor
Press Club Building
59A Ly Thai To Street
Hoan Kiem District
Hanoi, Vietnam
Phone +84 4 / 3936 7851
Fax +84 4 / 3936 8069
sg@HARTING.com

Distributors – worldwide



Farnell:
www.farnell.com

RS Components:
www.rs-components.com

Other countries and general contact



HARTING Electric GmbH & Co. KG
P.O. Box 1473, D-32328 Espelkamp
Phone +49 5772 47-97100
Fax + 49 5772 47-495
electric@HARTING.com



Pushing Performance

www.HARTING.com